

## AFVOERLEIDINGEN PVC - PE - PP



pag.1



pag. 2



pag. 3



HWA  
pag. 4



pag. 5



pag. 7



pag. 8



pag. 8



PP manchets  
pag. 10



PP manchets  
pag. 11



PP manchets  
pag. 12



pag. 13



pag. 14



pag. 14



pag. 15



lijm  
pag. 15



lijm  
pag. 17



pag. 18



pag. 21



pag. 22



pag. 23



pag. 24



pag. 24



manchet  
pag. 25



manchet  
pag. 26



manchet  
pag. 28

Afvoerputten 22  
Bevestigingsmateriaal 8  
Drainage 3  
Flexibele koppelingen 1

Hemelwaterafvoer 4  
Hulpstukken SN4 manchetsverbinding 25  
Hulpstukken lijmsverbinding 15  
Kolken en afsluiters 24

Lijnafwatering 23  
PP Buis en manchethulpstukken 12  
PVC Afvoerbuizen 12  
Stora-drain lijnafwatering 23

## FERNCO FLEXIBELE BUISKOPPELINGEN

Een Fernco koppeling is een flexibele verbinding, vervaardigd uit een PVC elastomeer, die in positie wordt gehouden door een RVS klemband. PVC Elastomeer heeft een zeer sterke trek- en scheursterkte, is enorm flexibel en niet onderhevig aan veroudering ("verrubberen"). Bestand tegen UV-straling, wortelgroei, rioolgas, bacteriën, chemicaliën etc. Leidingen van gelijke of verschillende afmetingen en/of materialen kunnen zonder problemen worden verbonden.

Fernco koppelingen zijn leverbaar in een groot aantal maten (32-685mm) en niet afhankelijk van het type buis. Zij kunnen worden aangebracht op elk type buis: PVC, PE, PP, staal, gietijzer, lood, koper, aluminium, beton, gres, asbest-cement etc. Het hoeft zelfs geen probleem te zijn indien u niet over de juiste maat koppeling beschikt. Fernco koppelingen beschikken over een enorme flexibiliteit. De koppelingen kunnen zelfs worden aangebracht op buizen waarvan de buitendiameter aanzienlijk kleiner is dan de maat waarvoor de koppeling werd ontworpen. Zelfs een verschil van 20mm is te overbruggen.

Fernco koppelingen zijn geschikt voor alle verbindingen met betrekking tot afvoerleidingen zoals: riool-, sanitair-, hemelwater afvoer, reparaties, aansluitingen etc. In principe kunnen de koppelingen worden toegepast op alle drukloze- of lage druk leidingen. Zeer snelle en eenvoudige montage, met een perfecte afdichting.

## RECHTE KOPPELING

code 454

Levertijd overige maten: 1 week.

KLEMBEREIK	ARTNR.	EURO
38-41 mm	<b>FC100</b>	14,75
62-62 mm	<b>FC102</b>	17,00
65-70 mm	<b>FC103</b>	19,90
90-101 mm	<b>FC105</b>	28,20
98-115 mm	<b>FC106</b>	27,55
120-136 mm	<b>FC108</b>	34,75
145-168 mm	<b>FC110</b>	61,20
209-219 mm	<b>FC114</b>	94,70



## VERLOOP KOPPELING

code 454

Levertijd overige maten: 1 week.

KLEMBEREIK	ARTNR.	EURO
75/88 - 50/63	<b>FC132</b>	27,35
120/133 - 98/115	<b>FC135</b>	34,75
155/163 - 111/101	<b>FC138</b>	66,65



## FLEXIBELE FITTINGEN

De ideale oplossing voor toepassingen waarin lijmen niet mogelijk of gewenst is. Geschikt voor herhaaldelijk gebruik. Ook wanneer de buisverbinding niet precies "haaks" of recht zijn passen deze fittingen zich aan. In de overzichtstabel ziet u voor welke uitwendige maten deze koppelingen geschikt zijn: uitwendige buismaat, maar ook de buitenmaat van PVC fittingen! Materiaal: PVC elastomeer. PVC Elastomeer heeft een zeer sterke trek- en scheursterkte, is enorm flexibel en niet onderhevig aan veroudering ("verrubberen").

UITWENDIG BUIS	UITWENDIG BUIS	UITWENDIG DRUKFITTING	KLEMBEREIK
1¼"	40mm	32	41-38 mm
1½"	50mm	40	50-44 mm
2"	63mm	50	63-57 mm
3"	90mm	75	90-82 mm
4"	110mm	90	110-100 mm

VOORBEELD

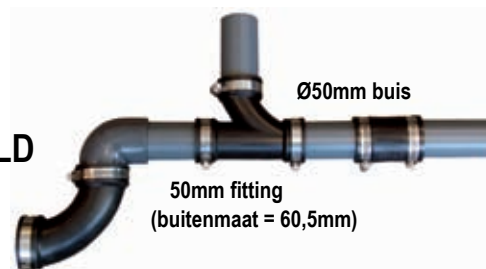

## FLEXIBELE SOK

code 454

MAAT	KLEMBEREIK	ARTNR.	EURO	DOOS
1¼" / 40mm	41-38 mm	FC119	2,95	100
1½" / 50mm	50-44 mm	FC120	3,25	100
2" / 63mm	63-57 mm	FC122	3,55	100
3" / 90mm	90-82 mm	FC126	4,95	80
4" / 110mm	110-100 mm	FC128	6,75	60



## FLEXIBELE VERLOOPSOK

code 454

MAAT	ARTNR.	EURO	DOOS
1½" x 1¼" / 50 x 40mm	FC140	3,15	100
2" x 1½" / 63 x 50mm	FC142	3,45	100
3" x 2" / 90 x 63mm	FC146	7,50	80
4" x 2" / 110 x 63mm	FC147	7,95	60
4" x 3" / 110 x 90mm	FC148	8,50	60



## FLEXIBELE BOCHT

code 454

MAAT	KLEMBEREIK	ARTNR.	EURO	DOOS
1½" / 50mm	50-44 mm	FC170	7,40	50
2" / 63mm	63-57 mm	FC172	7,95	20
3" / 90mm	90-82 mm	FC176	13,60	20
4" / 110mm	110-100 mm	FC178	17,40	6



## FLEXIBEL T-STUK

code 454

MAAT	KLEMBEREIK	ARTNR.	EURO	DOOS
1½" / 50mm	50-44 mm	FC150	8,65	50
2" / 63mm	63-57 mm	FC152	9,80	20
3" / 90mm	90-82 mm	FC156	16,80	20
4" / 110mm	110-100 mm	FC158	24,90	6



## FLEXIBELE EINDKAP

code 454

MAAT	KLEMBEREIK	ARTNR.	EURO	DOOS
1½" / 50mm	50-44 mm	FC160	2,10	160
2" / 63mm	63-57 mm	FC162	2,80	150
3" / 90mm	90-82 mm	FC166	3,75	100
4" / 110mm	110-100 mm	FC168	4,65	80



## DRAINAGE BUIS MET KOKOSVEZEL 090-1000 (750GR/M<sup>2</sup>)

code 448

\* Beschikbaarheid in overleg.

NOM. MAAT (MM)	ARTNR.	EURO/ MTR	ROL (MTR)
50	FP140	2,50	50
60	FP144	2,87	50
80	FP152	5,35	50
*100	FP156	7,85	50



## DRAINAGE BUIS MET PP-450 MU

code 448

\* Beschikbaarheid in overleg.

NOM. MAAT (MM)	ARTNR.	EURO/ MTR	ROL (MTR)
50	FP160	2,41	50
60	FP164	2,76	50
80	FP172	5,05	50
*100	FP176	7,60	50



## DRAINAGE BUIS KAAL, NIET OMWIKKELD

code 448

\* Beschikbaarheid in overleg.

NOM. MAAT (MM)	ARTNR.	EURO/ MTR	ROL (MTR)
50	FP120	1,05	50
*60	FP124	1,50	50
80	FP132	2,55	100
*100	FP136	4,53	100



## DRAINAGE BUIS BLIND, NIET OMWIKKELD

code 448

\* Beschikbaarheid in overleg.

NOM. MAAT (MM)	ARTNR.	EURO/ MTR	ROL (MTR)
*50	FP100	1,05	50
*60	FP104	1,50	50
*80	FP112	2,68	50
*100	FP116	4,53	50



## KLIKMOF

code 445

\* Beschikbaarheid in overleg.



DIAM.	ARTNR.	EURO
50	FP200	0,99
60	FP202	1,37
80	FP206	1,81
*100	FP208	2,46

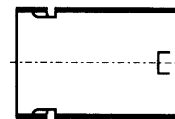

## T-STUK 90° (3 X KLIKVERBINDING)

code 445

\* Beschikbaarheid in overleg.

DIAM.	ARTNR.	EURO
50	FP210	5,10
60	FP212	5,55
80	FP216	6,15
*100	FP218	8,20

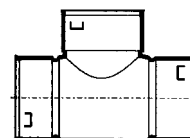

## VERLOOP T-STUK 90° (3 X KLIKVERBINDING)

code 445

\* Beschikbaarheid in overleg.

DIAM.	ARTNR.	EURO
80 x 50	FP220	6,00
*80 x 60	FP222	6,30
*100 x 80	FP232	8,90

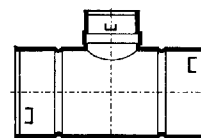

## VERLOOPSTUK (2 X KLIKVERBINDING)

code 445

\* Beschikbaarheid in overleg.

DIAM.	ARTNR.	EURO
80 x 50	FP240	2,59
*80 x 60	FP242	2,59
*100 x 80	FP246	3,62

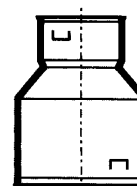

## PVC EINDSTOP

code 445

DIAM.	ARTNR.	EURO
50	FP248	0,45
60	FP250	0,51
80	FP254	0,82
100	FP256	1,39



## HWA BUIS GRIJS 33

code 421

Een afvoer van 80mm is geschikt om het water van 65m<sup>2</sup> dak af te voeren. Een afvoer van 100mm is geschikt om het water van 100m<sup>2</sup> dak af te voeren.

DIAMETER	LENGTE	ARTNR.	EURO/ MTR	PAKKET
70 x 67	4,00 mtr	FA202	2,49	432 mtr
80 x 77	4,00 mtr	FA204	2,90	336 mtr
80 x 77	5,55 mtr	FA210	2,90	466,2 mtr
100 x 96,4	4,00 mtr	FA206	4,45	192 mtr
100 x 96,4	5,55 mtr	FA212	4,45	266,4 mtr



## REGENWATER AFVOERPUT

code 409

PP regenwaterafvoerput met onderuitlaat 110mm spie, voorzien van uitneembaar waterslot, bladvanger, deksel met HWA-inlaat 100/80 en naar keuze toe te passen deksel of met rooster voor overstort.

TYPE	ARTNR.	EURO
HWA Afvoerput	FK248	43,20

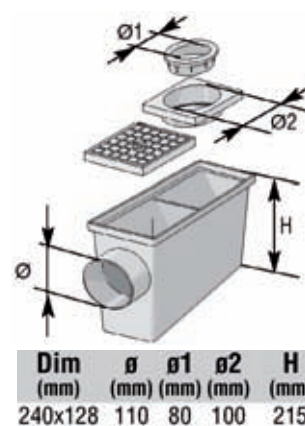

## HWA VERBINDINGSSTUK MOF/VERJ. SPIE-EIND

code 418

DIAM.	ARTNR.	EURO	DOOS
70 grijs	FA230	1,06	20
80 grijs	FA232	1,13	20
100 grijs	FA234	1,41	20

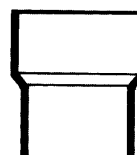

## HWA BOCHT 22° MOF/SPIE-EIND

code 418

\* Beschikbaarheid in overleg.

DIAM.	ARTNR.	EURO	DOOS
*70 grijs	FA238	1,78	100
80 grijs	FA240	2,26	50



## HWA BOCHT 45° MOF/VERJ. SPIE-EIND

code 418

DIAM.	ARTNR.	EURO	DOOS
70 grijs	FA246	1,27	20
80 grijs	FA248	1,44	20
100 grijs	FA250	2,22	20

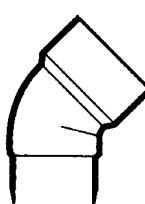

## HWA BOCHT 87° MOF/VERJ.SPIE-EIND

code 418

DIAM.	ARTNR.	EURO	DOOS
70 grijs	FA254	1,46	20
80 grijs	FA256	1,78	20
100 grijs	FA258	2,75	20

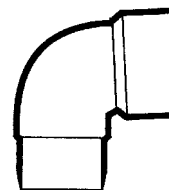

## HWA T-STUK 45° 2 x MOF/VERJ.SPIE-EIND

code 418

\* Beschikbaarheid in overleg.

DIAM.	ARTNR.	EURO	DOOS
*70 grijs	FA264	2,64	20
80 grijs	FA266	3,03	20
100 grijs	FA268	4,39	20

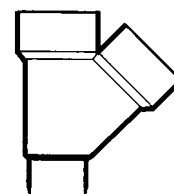

## HWA T-STUK 87° 2 x MOF/VERJ.SPIE-EIND

code 418

\* Beschikbaarheid in overleg.

DIAM.	ARTNR.	EURO	DOOS
*70 grijs	FA272	2,64	20
80 grijs	FA274	3,03	20
100 grijs	FA276	4,39	20

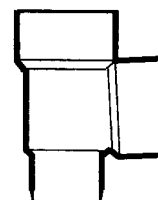

## HWA VERLOOPMOF

code 418

\* Beschikbaarheid in overleg.

DIAMETER	ARTNR.	EURO	DOOS
*80 x 70	FA280	2,73	20
*100 x 70	FA282	2,36	20
100 x 80	FA284	1,97	20



## INZET-VERLOOPRING HWA/HWA

code 418

DIAMETER	ARTNR.	EURO	DOOS
70 x 80	FA288	1,97	20
80 x 100	FA290	1,97	20



## INZET-VERLOOPRING HWA/RIOOL

code 418

DIAMETER mof x spie	ARTNR.	EURO	DOOS
70 x 50	FA296	1,55	20
70 x 75	FA300	1,77	20
80 x 50	FA298	1,71	20
80 x 75	FA302	1,84	20
80 x 110	FA304	2,64	20
80 x 125	FA306	2,64	20
100 x 110	FA308	2,64	20
100 x 125	FA310	2,64	20



## VERLOOPSTUK HWA/RIOOL

code 418

\* Beschikbaarheid in overleg.

DIAMETER mof x spie	ARTNR.	EURO	DOOS
80 x 110	FA320	4,34	54
100 x 110	FA322	4,26	45

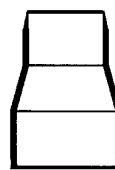

## KAP VOOR SPIE-EIND

code 406

\* Beschikbaarheid in overleg.

DIAM.	ARTNR.	EURO	DOOS
*70	FF644	1,39	10
80	FF646	1,39	10
*100	FF648	1,40	10



## SPECIEDEKSEL PE

code 409

\* Beschikbaarheid in overleg.

DIAM.	ARTNR.	EURO	DOOS
*70	FK108	0,79	10
80	FK112	0,79	10
*100	FK116	0,85	10



## HWA-SIFON

code 406

Voorzien van ontstoppingsschroefdeksel Ø 75mm.

\* Beschikbaarheid in overleg.

DIAM.	ARTNR.	EURO	DOOS
*80	FF692	10,65	20



## BLADAFSCHEIDER

code 409

\* Beschikbaarheid in overleg.

DIAMETER	ARTNR.	EURO
80 grijs	FK242	30,50
*110 grijs	FK240	40,50



## BLADVANGER

code 409

MM	ARTNR.	EURO	DOOS
60 - 75	FK244	0,79	50
80 - 100	FK246	0,79	50

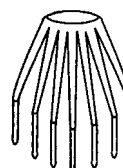

## PVC OPHANGBEUGEL ZONDER PEN GRIJS

code 427

Voorzien van moer en onverliesbare messing schroef. De beugel past op de inslagpen, de muurpen en de klemnok.  
Vanaf Ø110mm alleen te gebruiken voor onbelaste leidingen (ventilatie e.d.).

DIAM.	ARTNR.	EURO	DOOS
70	<b>FL106</b>	1,38	25
80	<b>FL110</b>	1,65	25
100	<b>FL114</b>	1,90	25
110	<b>FL116</b>	1,83	25
125	<b>FL118</b>	2,00	25



## INSLAGPEN VOOR PVC OPHANGBEUGEL

code 427

MAAT	ARTNR.	EURO	DOOS
'B'65mm	<b>FL132</b>	1,02	25/250



## MUURPEN "R"2

code 427

MAAT	ARTNR.	EURO	DOOS
'R'65mm	<b>FL136</b>	0,47	25/250



## KLEMNOK VOOR PVC OPHANGBEUGEL

code 427

MAAT	ARTNR.	EURO	DOOS
B1 M6	<b>FL140</b>	0,82	250
B1 M8	<b>FL142</b>	0,79	250



## MONTAGE-OGEN

code 427

MAAT	ARTNR.	EURO	DOOS
M6	<b>FL150</b>	1,40	50
M8	<b>FL152</b>	1,58	50



## HOUDDRAADPEN

code 427

Houtdraadpenen te monteren in klemnok of montage-oog.

TYPE	ARTNR.	EURO	DOOS
M6 x 60	<b>FL160</b>	0,40	100
M6 x 90	<b>FL162</b>	0,41	100
M8 x 90	<b>FL166</b>	0,75	100
M8 x 150	<b>FL170</b>	0,88	100



## KOPPELSTUK

code 427

Draadbusje voor het verlengen van o.a. de draadstang.

\* Beschikbaarheid in overleg.

TYPE	ARTNR.	EURO	DOOS
*M8 x 30	<b>FL202</b>	2,26	100



## DRAADSTANG

code 427

\* Beschikbaarheid in overleg.

TYPE	ARTNR.	EURO	DOOS
M8 x 1m	<b>FL222</b>	2,17	50
*M10 x 1m	<b>FL224</b>	2,91	25



## PVC ZADEL

code 427

MAAT	ARTNR.	EURO	DOOS
75	<b>FL178</b>	1,39	50
110	<b>FL180</b>	1,81	25



## THERMISCH VERZINKTE RIOLERINGSBEUGEL

code 427

Stalen beugel voor de bevestiging van rioleringsbuizen. Thermisch verzinkt.

\* Beschikbaarheid in overleg.

TYPE	ARTNR.	EURO	DOOS
50 x M8	<b>FL234</b>	3,67	25
63 x M8	<b>FL236</b>	3,58	25
75 x M8	<b>FL238</b>	4,45	25
110 x M8	<b>FL242</b>	5,80	25
160 x M8	<b>FL246</b>	6,75	25



## PP BUIS 4 MTR GLAD ZWART

code 815

Let op: deze buis is niet verlijmbaar en kan alleen met manchetfittingen worden gebruikt.

\* Beschikbaarheid in overleg.

MAAT	ARTNR.	EURO/METER	LENGTE
*40 x 34,0 mm	<b>SD102</b>	4,35	4 mtr
50 x 44,0 mm	<b>SD104</b>	5,75	4 mtr
75 x 69,0 mm	<b>SD106</b>	8,55	4 mtr
90 x 84,0 mm	<b>SD108</b>	11,05	4 mtr
110 x 103,2 mm	<b>SD110</b>	13,50	4 mtr



PP buis

## PE BUIS LENGTE 5 METER

code 451

Let op: deze buis is niet verlijmbaar en kan alleen met manchetfittingen worden gebruikt.

MAAT	ARTNR.	EURO/MTR	LENGTE
40 x 3 mm	<b>FB100</b>	2,86	5 mtr
50 x 3 mm	<b>FB102</b>	3,60	5 mtr
75 x 3 mm	<b>FB106</b>	5,55	5 mtr
90 x 3 mm	<b>FB108</b>	7,60	5 mtr
110 x 3,5 mm	<b>FB110</b>	10,55	5 mtr



PE buis

## STEEKMOF 2 x MANCHET ZWART

code 815

MAAT	ARTNR.	EURO
32 mm	<b>SD120</b>	1,56
40 mm	<b>SD122</b>	1,90
50 mm	<b>SD124</b>	2,00
75 mm	<b>SD126</b>	3,68
90 mm	<b>SD128</b>	6,05
110 mm	<b>SD130</b>	6,35
125 mm	<b>SD132</b>	7,55

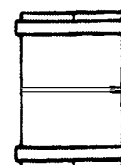

## OVERSCHUIFMOF 2 x MANCHET ZWART

code 815

MAAT	ARTNR.	EURO
40 mm	<b>SD142</b>	1,90
50 mm	<b>SD144</b>	2,07
75 mm	<b>SD146</b>	3,68
90 mm	<b>SD148</b>	6,05
110 mm	<b>SD150</b>	6,35
125 mm	<b>SD152</b>	8,65

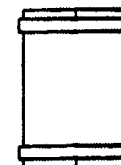

## BOCHT 45° 2 x MANCHET ZWART

code 815

MAAT	ARTNR.	EURO
32 mm	<b>SD160</b>	1,86
40 mm	<b>SD162</b>	2,00
50 mm	<b>SD164</b>	2,87
75 mm	<b>SD166</b>	4,56
90 mm	<b>SD168</b>	6,90
110 mm	<b>SD170</b>	7,20
125 mm	<b>SD172</b>	10,80

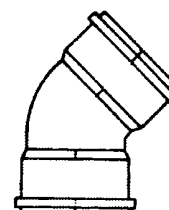

## BOCHT 87° 2 x MANCHET ZWART

code 815

MAAT	ARTNR.	EURO
32 mm	SD180	2,39
40 mm	SD182	2,64
50 mm	SD184	2,95
75 mm	SD186	5,40
90 mm	SD188	8,15
110 mm	SD190	8,20
125 mm	SD192	13,00

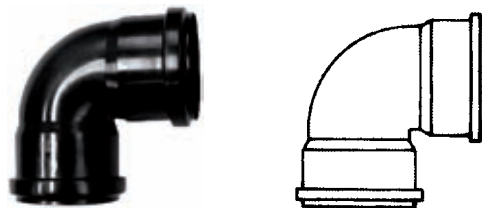

## BOCHT 45° SPIE/MANCHET ZWART

code 815

MAAT	ARTNR.	EURO
40 mm	SD202	1,67
50 mm	SD204	2,50
75 mm	SD206	4,56
90 mm	SD208	7,00
110 mm	SD210	7,40

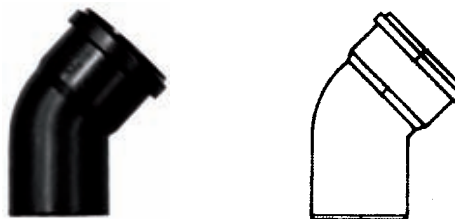

## BOCHT 87° SPIE/MANCHET ZWART

code 815

MAAT	ARTNR.	EURO
40 mm	SD222	2,21
50 mm	SD224	2,63
75 mm	SD226	4,96
90 mm	SD228	7,80
110 mm	SD230	8,05

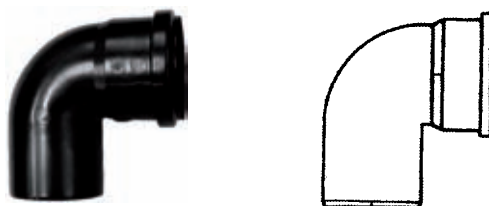

## T-STUK 45° 3 x MANCHET ZWART

code 815

MAAT	ARTNR.	EURO
32 mm	SD240	3,87
40 mm	SD242	4,09
50 mm	SD244	5,10
75 mm	SD246	8,40
90 mm	SD248	10,85
110 mm	SD250	13,50
125 mm	SD252	17,20

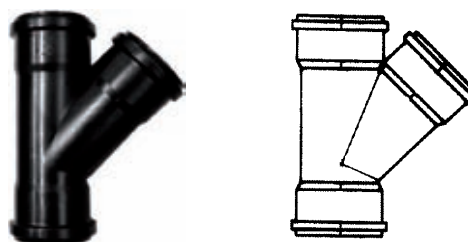

## T-STUK 87° 3 x MANCHET ZWART

code 815

MAAT	ARTNR.	EURO
32 mm	SD260	4,09
40 mm	SD262	4,75
50 mm	SD264	5,50
75 mm	SD266	9,30
90 mm	SD268	9,55
110 mm	SD270	13,05
125 mm	SD272	19,30

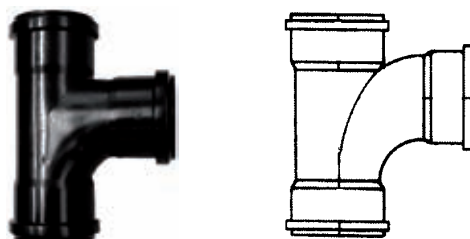

## T-STUK 45° 2 x MANCHET 1 x SPIE ZWART

code 815

MAAT	ARTNR.	EURO
40 mm	SD282	3,66
50 mm	SD284	4,83
75 mm	SD286	8,05
110 mm	SD290	11,90

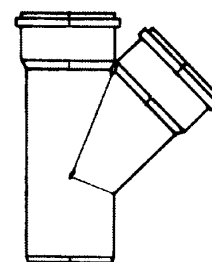

## T-STUK 87° 2 x MANCHET 1 x SPIE ZWART

code 815

MAAT	ARTNR.	EURO
40 mm	SD302	3,84
50 mm	SD304	5,40
75 mm	SD306	7,65
110 mm	SD310	11,40

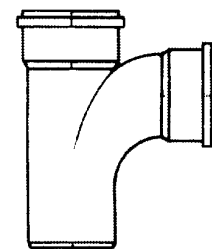

## VERLOOPRING EXCENTRISCH MANCHET/SPIE ZWART

code 815

MAAT	ARTNR.	EURO
50 x 40 mm	SD320	2,43
75 x 40 mm	SD322	3,84
75 x 50 mm	SD324	3,90
90 x 75 mm	SD326	4,30
110 x 40 mm	SD328	4,43
110 x 50 mm	SD330	4,43
110 x 75 mm	SD332	4,43
110 x 90 mm	SD334	5,30

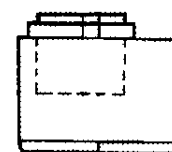

## AFSLUITKAP / EINDDOP ZWART

code 815

\* Beschikbaarheid in overleg.

MAAT	ARTNR.	EURO
*40 mm voor in de mof	SD340	1,30
50 mm voor in de mof	SD342	1,43
75 mm voor in de mof (grijs)	SD344	2,33
110 mm voor in de mof (grijs)	SD346	4,30
110 mm voor om de buis	SD348	4,43

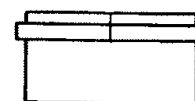

## AFVOERBUIZEN GRIJS ZONDER MOF

code 403

Buizen SN8 en SN4 KOMO-keur volgens NEN 7045 en 7029 voor rioolafvoer en rioolpersleidingen. Voor onderscheiding van de verschillende rioolstelsels (vuil en regenwater) zijn diverse diameters ook verkrijgbaar in de kleur RAL 8023 roodbruin (BR80) voor regenwater vrij verval en de kleur RAL7037 middengrijs (GR33) voor vuilwater vrij verval. K687 SN1 voorheen klasse 65. SN2 voorheen klasse 51. SN4 voorheen klasse 41. SN8 voorheen klasse 34. \* Beschikbaarheid in overleg.

MAAT	KLASSE	ARTNR.	EURO/MTR	WANDDIKTE	LENGTE	PAKKET
32	Ultra 3- SN4	FF102	2,21	± 3,0	5 mtr	1375 mtr
40	Ultra 3- SN4	FF104	2,77	± 3,0	5 mtr	840 mtr
50	Ultra 3- SN4	FF106	3,61	± 3,0	5 mtr	570 mtr
75	Ultra 3- SN2	FF108	4,02	± 1,8	5 mtr	500 mtr
75	Ultra 3- SN4	FF110	5,40	± 3,0	5 mtr	500 mtr
90	Ultra 3- SN2	FF114	4,48	± 1,8	5 mtr	252 mtr
90	Ultra 3- SN4	FF116	7,00	± 3,0	5 mtr	315 mtr
110	Ultra 3- SN2	FF120	6,05	± 2,2	5 mtr	425 mtr
110	Ultra 3- SN4	FF122	8,50	± 3,2	5 mtr	425 mtr
125	Ultra 3- SN2	FF128	7,80	± 2,5	5 mtr	340 mtr
125	Ultra 3- SN4	FF130	10,00	± 3,2	5 mtr	340 mtr
*125	Ultra 3- SN8	FF132	11,05	± 3,7	5 mtr	340 mtr
160	Ultra 3- SN2	FF138	12,95	± 3,2	5 mtr	195 mtr
160	Ultra 3- SN4	FF140	15,50	± 4,0	5 mtr	195 mtr
*160	Ultra 3- SN8	FF142	18,25	± 4,7	5 mtr	195 mtr
*200	Ultra 3- SN2	FF148	18,80	± 3,9	5 mtr	115 mtr
*200	Ultra 3- SN4	FF150	22,80	± 4,9	5 mtr	115 mtr
*200	Ultra 3- SN8	FF152	27,20	± 5,9	5 mtr	115 mtr
*250	Ultra 3- SN2	FF158	28,95	± 4,9	5 mtr	70 mtr
*315	Ultra 3- SN2	FF164	45,10	± 6,2	5 mtr	45 mtr
*400	Ultra 3- SN2	FF168	83,60	± 7,8	5 mtr	25 mtr



## AFVOERBUIS SN2 GRIJS MET MANCHETMOF

code 403

3-lagen afvoerbuus met manchetmof. Lengte is 5 of 6 meter. SN2 voorheen klasse 51. \* Beschikbaarheid in overleg.

MAAT	ARTNR.	EURO/MTR	WANDDIKTE	PAKKET
*110	FF240	6,75	± 2,2	425 mtr
*125	FF241	8,50	± 2,5	340 mtr
*160	FF242	14,25	± 3,2	195 mtr
*200	FF243	20,70	± 4,0	115 mtr
*250	FF244	31,90	± 4,9	70 mtr
*315	FF245	49,50	± 6,2	45 mtr
*400	FF246	91,55	± 7,9	



KLASSE 51 MANCHET

## LANDBOUWBUIS MET LIJMMOF

code 402

Dit type afvoerbuus is gemaakt van gerecycled pvc en wordt gebruikt voor diverse toepassingen in de land- en tuinbouw. Deze buis is niet gekeurd en heeft toleranties op de wanddikte. De buis wordt geleverd in lengtes van 5 mtr en zijn voorzien van lijmmof. Kleur is donkergrijs/zwart. \* Beschikbaarheid in overleg.

MAAT	ARTNR.	EURO/MTR
110 x ± 3,2 mm	BA800	8,50
125 x ± 3,2 mm	BA801	10,00
160 x ± 3,2 mm	BA802	12,95
200 x ± 4,0 mm	BA803	18,80
*250 x ± 5,0 mm	BA806	28,95
315 x ± 4,8 mm	BA810	35,15

Recycle buis met lijmmof



## HANDZAAG DUIFJE

code 151

Een zaag speciaal ontworpen voor PVC en ABS kunststofpijp maar zaagt ook gipsplaten, polyester panelen, hout met spijker restanten en tevens messing en koper pijpmateriaal.

TYPE	ARTNR.	EURO
Handzaag	<b>AK480</b>	40,55
Los zaagblad	<b>AK482</b>	20,30



## ZAAGKOORD VOOR KUNSTSTOF BUIS

code 151

- Ideaal voor moeilijk bereikbare plaatsen.
- Weinig zaagruimte nodig.
- RVS zaagkoord met voorgevormde handvaten.

TYPE	ARTNR.	EURO
Zaagkoord	<b>AK478</b>	28,10



## SNELSPAN BUIZENSIJDER VOOR KUNSTSTOF

code 151

\* Beschikbaarheid in overleg.

TYPE	ARTNR.	EURO
Buizensnijder 10 - 63 mm	<b>AK484</b>	158,00
Reservemesje 10 - 63 mm	<b>AK486</b>	38,20
Buizensnijder 50 - 110 mm	<b>AK488</b>	182,00
Reservemesje 50 - 110 mm	<b>AK490</b>	43,55
*Buizensnijder 110 - 160 mm	<b>AK492</b>	193,00
Reservemesje 110 - 160 mm	<b>AK494</b>	47,90



## OPBLAASBARE BUISAFSLUITER

code 148

Unieke buisafsluiters voor alle buizen en bodemafvoeren in rioleringen en vijvers. Verkrijgbaar van 48 tot 320mm. Lengte van de slang 1,5 meter. Op te pompen met losse handpomp. De 92-145mm versie is nu ook leverbaar met 3 meter slang en een afsluiter met 9mm tule aansluiting.

TYP	ARTNR.	EURO
Opblaasbare buisafsluiter 48 - 72 mm	<b>AH600</b>	58,20
Opblaasbare buisafsluiter 72 - 92 mm	<b>AH602</b>	58,55
Opblaasbare buisafsluiter 92 - 145 mm	<b>AH604</b>	61,75
Opblaasbare buisafsluiter 92 - 145 mm met 3 mtr slang	<b>AH605</b>	82,20
Opblaasbare buisafsluiter 145 - 200 mm	<b>AH606</b>	99,45
Opblaasbare buisafsluiter 200 - 320 mm	<b>AH608</b>	202,00
Handpomp	<b>AH610</b>	11,75



## FLEXIBOCHT DUBBELE LIJMMOF

code 406

Moeilijke aansluitingen bestaan niet meer, maak nu uw eigen hulpstuk!  
Neemt iedere gewenste buiging aan van 0° tot 120°, zelfs op twee verschillende niveaus. Compenseert een niveauverschil tussen twee buizen. Gemakkelijk en snel te installeren. Vervangt alle PVC bochten: slechts 1 hulpstuk voor de diameters 40 en 50mm. Past zich gemakkelijk aan op reeds geïnstalleerde buizen. PVC verlijmbaar.



DIAM.	ARTNR.	EURO
40	FF294	5,25
50	FF295	10,05

## DUBBELE LIJMMOF SN4

code 406

Alle artikelen zijn voorzien van KOMO-keur.

\* Beschikbaarheid in overleg.



DIAM.	ARTNR.	EURO	DOOS
32	FF300	0,50	10/100
40	FF302	0,55	10/100
50	FF304	0,64	10/100
75	FF306	1,96	20
90	FF308	1,96	20
110	FF310	2,19	20
125	FF312	2,80	20
160	FF314	5,70	20
200	FF316	16,25	18
*250	FF317	18,10	1
315	FF318	20,25	1

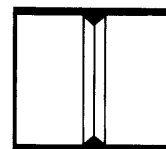

## OVERSCHUIFMOF 2 x MANCHET SN4

code 406

\* Beschikbaarheid in overleg.

DIAM.	ARTNR.	EURO	DOOS
*32	FF320	2,83	25
*40	FF322	3,33	5/50
50	FF324	3,58	5/50
75	FF326	5,30	5/30

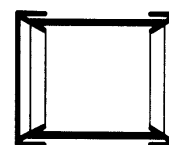

## EXPANSIESTUK 2-DELIG SN4

code 406

\* Beschikbaarheid in overleg.

DIAM.	ARTNR.	EURO	DOOS
*40	FF680	5,40	5
*50	FF682	5,55	5
75	FF684	7,85	10
110	FF686	8,50	10
*125	FF688	9,20	10
*160	FF690	15,35	10

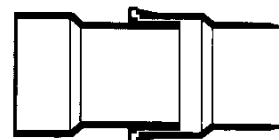

### BOCHT 15° 2 x MOF SN4

code 406

\* Beschikbaarheid in overleg.

DIAM.	ARTNR.	EURO	DOOS
110	FF330	4,04	20
*125	FF332	5,90	20

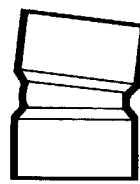

### BOCHT 22° MOF/SPIE SN4

code 406

DIAM.	ARTNR.	EURO	DOOS
75	FF336	2,43	10
110	FF338	3,78	45
125	FF340	5,80	20



### BOCHT 30° 2 x MOF SN4

code 406

DIAM.	ARTNR.	EURO	DOOS
110	FF344	4,54	20
125	FF346	6,60	20

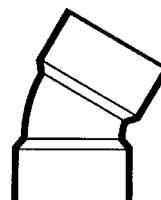

### BOCHT 45° MOF/SPIE SN4

code 406

DIAM.	ARTNR.	EURO	DOOS
32	FF348	0,60	10/100
40	FF350	0,64	10/100
50	FF352	1,21	10/100
75	FF354	2,43	20
110	FF356	3,78	30
125	FF358	5,80	20
160	FF360	11,55	5



### BOCHT 45° 2 x MOF SN4

code 406

DIAM.	ARTNR.	EURO	DOOS
32	FF362	0,60	10/100
40	FF364	0,64	10/100
50	FF366	1,21	10/100
75	FF368	2,43	20
90	FF370	3,23	20
110	FF372	3,78	30
125	FF374	5,80	20
160	FF376	11,55	5

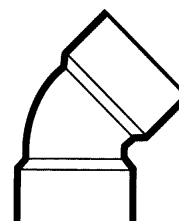

## BOCHT 88° MOF/SPIE SN4

code 406

DIAM.	ARTNR.	EURO	DOOS
32	FF380	0,64	10/100
40	FF382	0,85	10/100
50	FF384	1,27	10/100
75	FF386	2,58	20
90	FF387	4,57	20
110	FF388	5,20	20
125	FF390	7,20	10
160	FF392	13,55	5

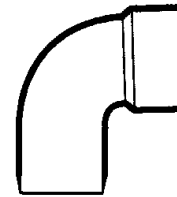

## BOCHT 88° 2 x MOF SN4

code 406

DIAM.	ARTNR.	EURO	DOOS
32	FF400	0,64	10/100
40	FF402	0,85	10/100
50	FF404	1,27	10/100
75	FF406	2,58	20
90	FF408	3,82	20
110	FF410	5,20	20
125	FF412	6,65	10
160	FF414	13,55	6

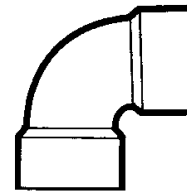

## T-STUK 45° 2 x MOF/SPIE SN4

code 406

DIAM.	ARTNR.	EURO	DOOS
50	FF422	2,96	25
75	FF424	4,21	10
110	FF426	7,20	20

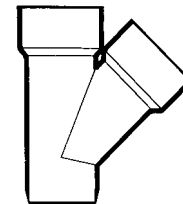

## VERLOOP T-STUK 45° 2 x MOF/SPIE SN4

code 406

\* Beschikbaarheid in overleg.

DIAMETER	ARTNR.	EURO	DOOS
*75 x 50	FF432	3,80	50
110 x 50	FF436	5,25	40

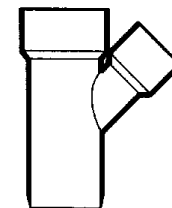

## T-STUK 45° 3 x MOF SN4

code 406

DIAM.	ARTNR.	EURO	DOOS
32	FF444	1,41	10/100
40	FF446	1,59	10/100
50	FF448	2,58	50
75	FF450	4,21	20
90	FF452	6,55	20
110	FF454	6,30	10
125	FF456	9,20	10
160	FF458	19,55	5

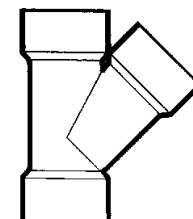

### DUBBEL T-STUK 45° EN 88° 3 x MOF 1 x SPIE SN4

code 406

TYPE	DIAM.	ARTNR.	EURO	DOOS
Dubbel T-stuk 45° 3 x mof, 1 x spie	110	FF522	14,95	10
Dubbel T-stuk 88° 3 x mof, 1 x spie	110	FF523	12,30	15



### VERLOOP T-STUK 45° 3 x MOF SN4

code 406

\* Beschikbaarheid in overleg.

DIAM.	ARTNR.	EURO	DOOS
75 x 50	FF466	3,78	10-25
110 x 40	FF468	5,25	10-25
110 x 50	FF470	5,25	20
110 x 75	FF472	6,05	20
*125 x 50	FF476	7,95	20
*125 x 75	FF478	7,95	15
125 x 110	FF480	7,95	10
160 x 110	FF482	19,55	5
*160 x 125	FF484	19,55	8

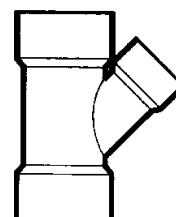

### VERLOOP T-STUK 45°, 2 x MANCHET/1 x LIJMMOF SN4

code 406

DIAM.	ARTNR.	EURO	DOOS
110 x 50	FF490	7,10	20
110 x 75	FF492	8,10	15

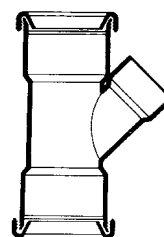

### T-STUK 88° 2 x MOF/ 1 x SPIE SN4

code 406

DIAM.	ARTNR.	EURO	DOOS
50	FF504	3,17	25
75	FF506	3,78	10
110	FF508	7,25	20

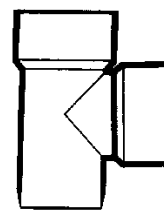

### T-STUK 88° 3 x MOF SN4

code 406

DIAM.	ARTNR.	EURO	DOOS
32	FF524	1,41	100
40	FF526	1,59	100
50	FF528	2,58	50
75	FF530	3,78	20
90	FF532	6,00	20
110	FF534	5,95	10
125	FF536	7,00	10
160	FF538	18,05	5

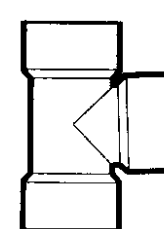

### VERLOOP T-STUK 88° 3 x MOF SN4

code 406

DIAM.	ARTNR.	EURO	DOOS
75 x 40	FF542	3,40	20
75 x 50	FF544	3,40	20
110 x 40	FF546	5,25	25
110 x 50	FF548	5,25	20
110 x 75	FF550	5,85	20
*125 x 50	FF554	6,90	10
*125 x 75	FF556	6,90	10
*125 x 110	FF558	6,90	10
160 x 110	FF560	17,10	5

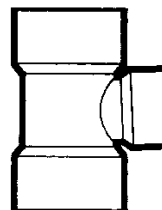

### VERLOOP T-STUK 88GR, 2 x MANCHET / 1 X LIJMMOF SN4

code 406

DIAM.	ARTNR.	EURO	DOOS
110 x 50	FF568	7,10	20

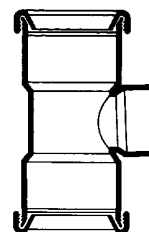

### INZETVERLOOPSTUK EXCENTRISCH SN4

code 406

DIAM.	ARTNR.	EURO	DOOS	DIAM.	ARTNR.	EURO	DOOS
40 x 32	FF578	0,55	100	110 x 75	FF596	2,26	20
50 x 32	FF580	0,85	100	110 x 90	FF598	2,28	20
50 x 40	FF582	0,85	100	125 x 40	FF600	2,30	20
75 x 40	FF584	1,46	100	125 x 50	FF602	2,30	20
75 x 50	FF586	1,55	100	125 x 75	FF604	2,30	20
90 x 75	FF588	2,03	20	125 x 110	FF606	2,30	20
110 x 40	FF590	2,26	20	160 x 110	FF608	6,60	20
110 x 50	FF592	2,26	20	160 x 125	FF610	6,60	20
110 x 2x50	FF594	2,48	20				



### INZET / REPARATIESTUK VOOR RIOOLBUIS MOF / VERJONGINGSPIE

code 406

Een echte probleemoplosser is het reparatiestuk in 32, 40, 50, 110 en 125 mm. Het probleem: een afvoerleiding is gelijk met de vloer of de wand afgezaagd. Wordt het uithakken? Vloer open? Nee, het kan met dit reparatiestuk. Het hulpstuk met mof en een verjongd spie-einde past in de buis en vandaar kunt u weer uitbreiden!

\* Beschikbaarheid in overleg.

MOF x SPIE	ARTNR.	EURO
32 x 26	FF280	1,30
40 x 34	FF281	1,68
50 x 44	FF282	2,02
110 x 103	FF286	7,10
*125 x 118	FF287	8,10

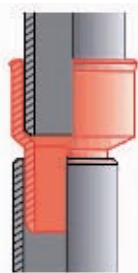

### ONTSTOPPINGSSTUK MET SCHROEFDEKSEL, MOF/SPIE SN4

code 406

DIAM.	ARTNR.	EURO	DOOS
110	FF614	10,65	10
125	FF616	13,25	10

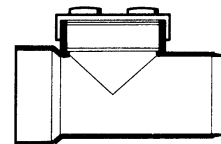

### ONTSTOPPINGSSTUK MET SCHROEFDEKSEL, MANCHETVERBINDING MOF/SPIE SN4

code 406

\* Beschikbaarheid in overleg.

DIAM.	ARTNR.	EURO	DOOS
110	FF620	10,65	10
125	FF622	14,55	10
*160	FF624	23,05	5

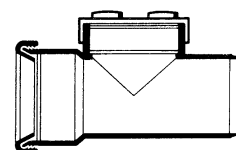

### EINDSTUK MET SCHROEFDEKSEL SN4

code 406

\* Beschikbaarheid in overleg.

DIAM.	ARTNR.	EURO	DOOS
*32	FF626	2,09	10
40/50	FF628	2,48	5
75	FF630	3,25	20
110	FF632	4,17	20
125	FF634	5,55	20
160	FF636	10,90	15
200	FF638	19,20	20



### KAP VOOR SPIE-EIND SN4

code 406

DIAM.	ARTNR.	EURO	DOOS
32	FF640	0,52	10/100
40	FF641	0,53	10/100
50	FF642	0,59	10/100
75	FF645	1,37	10/100
110	FF650	1,40	20
125	FF652	1,55	20
160	FF654	3,36	20



### SPECIEDEKSEL PE

code 409

Tweezijdige toepassing: passend **om** het spie-eind en **in** het mofeind. \* Beschikbaarheid in overleg.



DIAM.	ARTNR.	EURO	DOOS		DIAM.	ARTNR.	EURO	DOOS
32	FK100	0,49	25/250		90	FK114	0,85	500
40	FK102	0,49	25/250		*100	FK116	0,85	500
50	FK104	0,62	25/250		110	FK118	0,85	500
63	FK106	0,75	500		125	FK120	1,10	500
*70	FK108	0,79	1000		160	FK122	1,82	300
75	FK110	0,75	500		200	FK124	5,00	30
80	FK112	0,79	1000					



### KLEMAANBOORZADEL 110 X 50 MM

code 406

D.m.v. wartel wordt een rubber klemring aangedraaid.  
Het te boren gat moet **57 mm** zijn.

TYPE	ARTNR.	EURO
Klemzadel 110 x 50 mm (manchetmof)	FF669	6,25



### KLEMZADELS

code 406

Zadel dat om buis 110 wordt verlijmd om zo gemakkelijk een aftakking te maken.

DIAM.	ARTNR.	EURO	DOOS
110 x 40	FF666	2,22	200
110 x 50	FF668	2,36	200



### UNIVERSELE LIJMSIFON MET ONTSTOPPING TYPE M

code 409

\* Beschikbaarheid in overleg.

TYPE	ARTNR.	EURO	DOOS
32 mm	FK180	4,16	150
40 mm	FK182	4,85	100
*Beluchter voor hulpbeluchting 32/40 mm	FK222	8,85	20



### RUBBER OVERGANGSSTUK PVC/METAAL

code 406

Passend in mof. \* Beschikbaarheid in overleg.

DIAM.	ARTNR.	EURO	DOOS
40 x 30	FF672	1,42	5
*40-50 x 40	FF674	1,13	5
*75 x 50	FF678	2,70	25

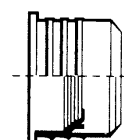

## VLOERPUT NR. 402

code 409

ABS put met onderuitlaat, met emmer. Voorzien van RVS rooster.  
Inbouwhoogte 187mm, waterslot 50mm, uitlaat 75mm.

MAAT	ARTNR.	EURO
200 x 200	FK200	38,70

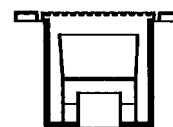

## VLOERPUT NR. 403

code 409

ABS put met zij-uitlaat, met emmer. Voorzien van RVS rooster.  
Inbouwhoogte 140mm. Bovenkant tot hart uitlaat: 76mm, uitlaat 75mm.

MAAT	ARTNR.	EURO
200 x 200	FK202	49,40

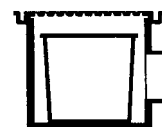

## SLAGVASTE PVC-VLOERPUT

code 409

Kleur: lichtgrijs, slagvast PVC, ondereind is als spie-eind uitgevoerd.

MAAT	ARTNR.	EURO
100 x 100 onderuitlaat 40 mm	FK204	12,30
150 x 150 onderuitlaat 40/50 mm	FK206	12,45
200 x 200 onderuitlaat 63/75 mm	FK208	18,75
250 x 250 onderuitlaat 90/110 mm	FK210	32,65
300 x 300 onderuitlaat 100/110 mm	FK212	41,05

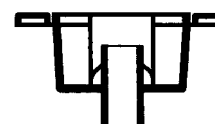

## TYLEEN EMMERPUT

code 409

Ronde onderbouw. Tyleen rand voor waterdichte betonhechting.  
Tyleen deksel. Onderuitlaat 75mm.

MAAT	ARTNR.	EURO
200 x 200	FK216	14,30

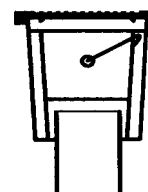

## VLOERPUT GIETIJZER

code 409

PE vloerput voorzien van kunststof emmer. Onderuitlaat spie 75mm.  
Met gietijzer rand en rooster.

MAAT	ARTNR.	EURO
200 x 200	FK220	31,05

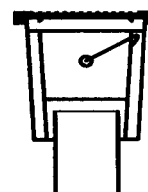

## WAVIN LIJNAFWATERING IN POLYPROPYLEEN (ZWART)

code 457

Ideaal voor garagedeuren, terrassen, parkeerplaatsen en rondom vijvers en zwembaden. Wavin kunststof lijnafwatering is geschikt voor een belastingsklasse A-15. Goten zijn inclusief rooster kleur zwart.

<sup>1</sup> Onderuitlaat aansluiten met u3-buis 110mm.

<sup>2</sup> Uitlaat aan te sluiten met wafix hulpstukken 110mm.



TYPE	ARTNR.	EURO	H	Ø	B
<sup>1</sup> Goot 1 meter incl. kunststof rooster	FD230	20,85	130mm	103mm	142mm
<sup>1</sup> Goot 0,5 meter incl. kunststof rooster	FD232	20,25	130mm	103mm	142mm
Eindplaat	FD234	3,04	-	-	-



## KUNSTSTOF AFVOERGoot (PP)

code 457

Compleet gemonteerde lichtgewicht elementen, onbreekbaar en eenvoudig aansluitbaar voor een HWA afvoer.

Ideaal voor garagedeuren, terrassen, parkeerplaatsen en rondom vijvers en zwembaden.

Versterkte kunststof goot, leverbaar met gegalvaniseerd rooster of kunststof rooster.

Afmetingen goot met gegalvaniseerd rooster: L 1000 x B 130 x D 98mm.

Afmetingen goot voor kunststof rooster: L 1000 x B 130 x D 115mm.

Beide goten vallen onder Klasse A (1,5 ton belasting).

- gootelementen worden door een mof/spie verbinding aan elkaar gekoppeld.

- geïntegreerde voetsteunen vergemakkelijken de plaatsing.

- op de gootelementen staat de vereiste inbouwdiepte aangegeven.

- in/uitloop aansluitingen verlijmbaar.

Kunststofrooster op aanvraag leverbaar in de kleur beige.

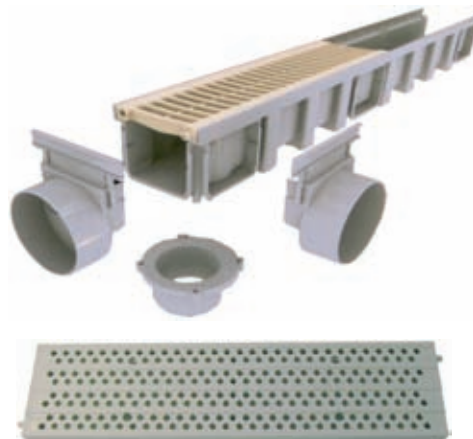

TYPE	ARTNR.	EURO
Afvoergoot 1 meter <b>inclusief</b> gegalvaniseerd rooster	FD210	22,40
Afvoergoot 1 meter <b>exclusief</b> kunststof rooster	FD214	15,10
Sleufrooster kunststof lichtgrijs (L= 50 cm)	FD216	14,15
Zwembadrooster kunststof lichtgrijs (L= 50 cm)	FD218	11,85
Eind/beginstuk Ø110mm	FD222	3,91

## STORADRAIN LIJNAFWATERING

code 457

Afvoergoten in polyesterbeton. Breedte 100mm inwendig, 125mm uitwendig, hoogte 115mm, klasse A (max 1,5 ton belastbaar).

Leverbaar tot breedte van 30 cm, tot 60 ton belasting!

Let op: rooster apart bestellen! Roosters ook leverbaar in RVS, koper en messing.



TYPE	ARTNR.	EURO
goot B=10cm L=100cm ( <b>exclusief rooster</b> )	FD101	21,15
goot B=10cm L = 50cm ( <b>exclusief rooster</b> )	FD105	16,95
verzinkt rooster B=10cm L=100cm	FD102	15,30
verzinkt rooster B=10cm L=50cm	FD106	13,15
gietijzeren rooster B=10cm L=50cm	FD107	18,50
verankeringsbout t.b.v. gietijzeren rooster (2 per meter)	FD120	3,84
begin/eindstuk	FD108	7,00
eindstuk met uitlaat 110	FD112	15,65

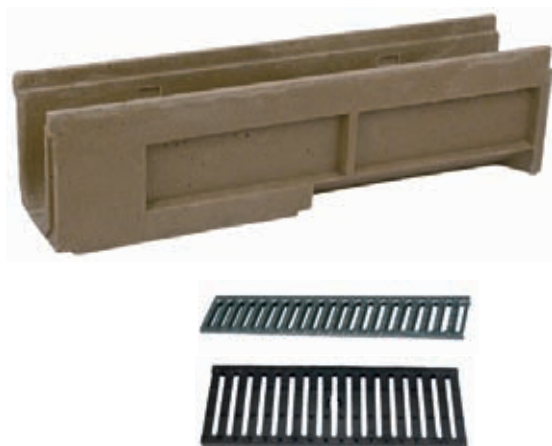

## KOLKEN

Diameter afvoer: 125mm spie-eind voor directe aansluiting op T-stuk of bocht met dubbele mof, in slagvaste uitvoering, kleur: geel. Unieke verbinding tussen bovenstuk en onderbak, het zgn. H-principe. Onderbak draaibaar in alle richtingen. Bovenstuk extra stabiel door verlengd spie-end. De kolken zijn voorzien van KOMO-keur volgens NEN7057 en NEN7067.

## STRAATKOLKEN & ONDERBAKKEN

code 409

- Gietijzeren rooster of deksel,
- klasse X: normaal verkeer.
- onderbak aansluiting 125mm spie, Ø315mm, hoogte 640mm
- pvc onderbak met slagvaste pvc stankafsluiter en glasvezel versterkte bodem.



Basic

Klasse X

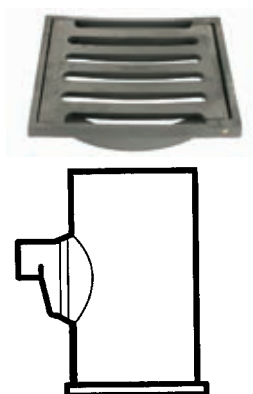

TYPE	ARTNR.	EURO
Gietijzeren kop Basic <b>excl.</b> onderbak	<b>FK401</b>	91,75
Onderbak voor Basic	<b>FK430</b>	63,60
Gietijzeren kop klasse X <b>excl.</b> onderbak	<b>FK400</b>	150,00
Onderbak voor klasse X	<b>FK432</b>	90,05

## HDPE SCHUIFKRANEN

code 454

Economische schuifkranen voor lage druk. Vervaardigd uit HDPE. Voorzien van 2 x spie verbinding. Te monteren met manchetfittingen. Deze kranen zijn ontworpen voor dikkere media en kunnen bij zuiver water wat doorlekken. \* Beschikbaarheid in overleg.

DIAM.	ARTNR.	EURO
*125	<b>FC200</b>	325,00
*160	<b>FC202</b>	325,00
*200	<b>FC204</b>	349,00
*250	<b>FC206</b>	452,00
*315	<b>FC208</b>	595,00



## SN4 MANCHETVERBINDING

Kleur: RAL7037 middengrijs. Verbinding: steekverbinding, vaste rubbermanchet.

Keur: SN4 en SN8 (op aanvraag): KOMO-keur volgens NEN7046, v.z.v.t. SN4 was voorheen klasse 41

### STEEKMOF SN4

code 436

\* Beschikbaarheid in overleg.

DIAM.	ARTNR.	EURO	DOOS
110	FF700	3,82	20
125	FF701	5,20	20
160	FF702	8,35	16
200	FF703	18,10	10
*250	FF704	25,70	4
*315	FF705	37,45	3

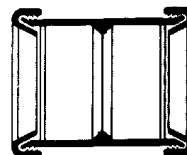

### OVERSCHUIFMOF SN4

code 436

\* Beschikbaarheid in overleg.

DIAM.	ARTNR.	EURO	DOOS
110	FF712	3,82	20
125	FF713	5,20	20
160	FF714	8,35	16
200	FF715	18,10	10
*250	FF716	25,70	4
*315	FF717	37,45	3

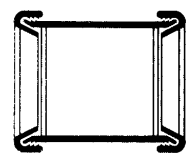

### BOCHT 15° MOF/SPIE SN4

code 436

\* Beschikbaarheid in overleg.

DIAM.	ARTNR.	EURO	DOOS
110	FF722	5,50	20
*125	FF723	6,95	20
*160	FF724	13,45	5
*200	FF725	37,75	4

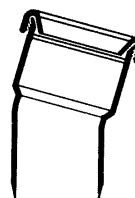

### BOCHT 15° 2 x MOF SN4

code 436

\* Beschikbaarheid in overleg.

DIAM.	ARTNR.	EURO	DOOS
110	FF730	6,35	20
*125	FF731	6,85	20

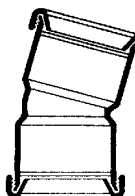

### BOCHT 30° MOF/SPIE SN4

code 436

\* Beschikbaarheid in overleg.



DIAM.	ARTNR.	EURO	DOOS
110	FF734	6,00	20
*125	FF735	6,95	20
*160	FF736	13,65	5
*200	FF737	37,75	4

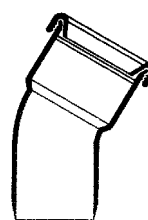

### BOCHT 30° 2 x MOF SN4

code 436

\* Beschikbaarheid in overleg.

DIAM.	ARTNR.	EURO	DOOS
110	FF744	6,35	20
*125	FF745	9,10	20
*160	FF746	15,20	5



### BOCHT 45° MOF/SPIE SN4

code 436

\* Beschikbaarheid in overleg.

DIAM.	ARTNR.	EURO	DOOS
110	FF750	5,50	20
125	FF751	6,95	20
*160	FF752	13,45	5
*200	FF753	38,50	4
*250 kort	FF755	71,55	1
*315 kort	FF757	122,00	1



### BOCHT 45° 2 x MOF SN4

code 436

\* Beschikbaarheid in overleg.

DIAM.	ARTNR.	EURO	DOOS
110	FF763	6,35	20
125	FF764	8,10	20
160	FF765	14,80	5
*200	FF766	30,05	4
*250 kort	FF768	82,25	1
*315 kort	FF770	153,00	1

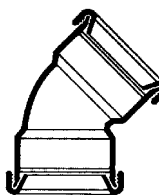

## BOCHT 88° MOF/SPIE SN4

code 436

\* Beschikbaarheid in overleg.



DIAM.	ARTNR.	EURO	DOOS
110	FF775	5,65	20
125	FF776	7,90	10
*160	FF777	15,20	5
*200	FF778	40,65	3
*250 kort	FF780	90,90	1
*315 kort	FF782	172,00	1

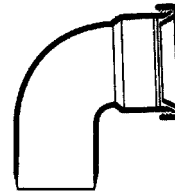

## BOCHT 88° 2 x MOF SN4

code 436

\* Beschikbaarheid in overleg.

DIAM.	ARTNR.	EURO	DOOS
110	FF785	6,55	20
125	FF786	8,95	10
160	FF787	16,65	5
200	FF788	38,05	3
*250 kort	FF790	115,00	1
*315 kort	FF792	192,00	1

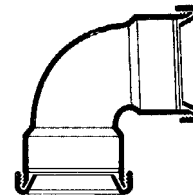

## T-STUK 45° 2 x MOF/ 1 x SPIE SN4

code 436

\* Beschikbaarheid in overleg.

DIAM.	ARTNR.	EURO	DOOS
110	FF796	8,15	10
*125	FF797	10,65	5
*160	FF798	27,15	4
*200	FF799	179,00	1

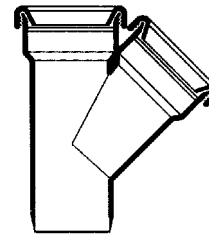

## T-STUK 45° 3 x MOF SN4

code 436

\* Beschikbaarheid in overleg.

DIAM.	ARTNR.	EURO	DOOS
110	FF803	9,00	10
125	FF804	11,80	8
160	FF805	24,40	4
*200	FF806	47,75	4
*250	FF807	224,00	2
*315	FF808	345,00	1

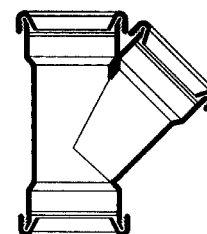

## VERLOOP T-STUK 45° 3 x MOF SN4

code 436

\* Beschikbaarheid in overleg.



DIAM.	ARTNR.	EURO	DOOS
125 x 110	<b>FF813</b>	11,20	10
160 x 110	<b>FF814</b>	23,60	5
160 x 125	<b>FF815</b>	23,60	5
*200 x 125	<b>FF816</b>	42,05	4
*200 x 160	<b>FF817</b>	44,35	4
*250 x 125	<b>FF818</b>	176,00	1
*250 x 160	<b>FF819</b>	177,00	1
*250 x 200	<b>FF820</b>	190,00	1
*315 x 125	<b>FF821</b>	266,00	1
*315 x 160	<b>FF822</b>	273,00	1
*315 x 200	<b>FF823</b>	280,00	1
*315 x 250	<b>FF824</b>	286,00	1

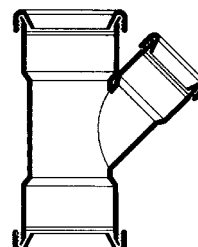

## T-STUK 88° 2 x MOF/ 1 x SPIE SN4

code 436

\* Beschikbaarheid in overleg.

DIAM.	ARTNR.	EURO	DOOS
110	<b>FF830</b>	7,80	10
*125	<b>FF831</b>	10,00	10
*160	<b>FF832</b>	25,25	5
*200	<b>FF833</b>	67,45	1

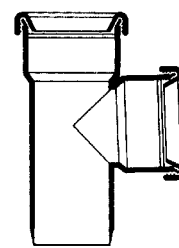

## T-STUK 88° 3 x MOF SN4

code 436

\* Beschikbaarheid in overleg.

DIAM.	ARTNR.	EURO	DOOS
110	<b>FF837</b>	8,75	10
125	<b>FF838</b>	10,30	10
160	<b>FF839</b>	22,90	5
200	<b>FF840</b>	44,10	3
*250	<b>FF841</b>	143,00	1
*315	<b>FF842</b>	273,00	1

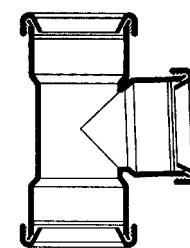

## VERLOOP T-STUK 88° 3 x MOF SN4

code 436

\* Beschikbaarheid in overleg.



DIAM.	ARTNR.	EURO	DOOS
125 x 110	<b>FF847</b>	10,75	10
160 x 110	<b>FF848</b>	21,20	5
*160 x 125	<b>FF849</b>	21,20	5
*200 x 125	<b>FF850</b>	36,70	4
*200 x 160	<b>FF851</b>	39,75	4
*250 x 125	<b>FF852</b>	169,00	1
*250 x 160	<b>FF853</b>	175,00	1
*250 x 200	<b>FF854</b>	182,00	1
*315 x 125	<b>FF855</b>	238,00	1
*315 x 160	<b>FF856</b>	245,00	1
*315 x 200	<b>FF857</b>	252,00	1
*315 x 250	<b>FF858</b>	259,00	1

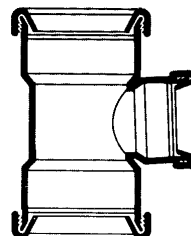

## INZETVERLOOPSTUK MOF/SPIE EXCENTRISCH SN4

code 436

DIAM.	ARTNR.	EURO	DOOS
110 x 125	<b>FF863</b>	5,40	20
110 x 160	<b>FF864</b>	9,75	20
125 x 160	<b>FF865</b>	10,10	20
125 x 200	<b>FF866</b>	23,35	5
160 x 200	<b>FF867</b>	24,05	5



## VERLOOPSTUK MOF/SPIE EXCENTRISCH SN4

code 436

\* Beschikbaarheid in overleg.

DIAM.	ARTNR.	EURO	DOOS
*200 x 250	<b>FF871</b>	53,90	8
*250 x 315	<b>FF872</b>	74,30	1

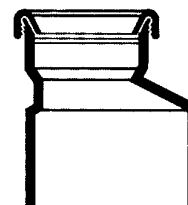

## KAP VOOR SPIE-EIND SN4

code 406

\* Beschikbaarheid in overleg.

DIAM.	ARTNR.	EURO	DOOS
110	<b>FF650</b>	1,40	20
125	<b>FF652</b>	1,55	20
160	<b>FF654</b>	3,36	20
200	<b>FF656</b>	4,43	10
250	<b>FF658</b>	9,55	10
315	<b>FF660</b>	12,50	15
400	<b>FF662</b>	32,45	8
*500	<b>FF664</b>	70,80	1



## ONTSTOPPINGSSTUK MOF/SPIE MET SCHROEFDEKSEL SN4

code 406

\* Beschikbaarheid in overleg.



DIAM.	ARTNR.	EURO	DOOS
110	FF620	10,65	10
125	FF622	14,55	10
*160	FF624	23,05	5

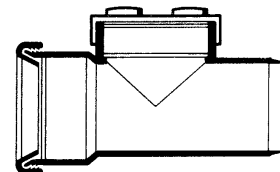

## GRIFFON SILICONENSPRAY & MULTISPRAY

code 151

Siliconenspray is geschikt als universeel smeermiddel dat beschermt tegen vocht en vuil op basis van zuivere siliconenolie. Tevens geschikt als reinigingsmiddel voor diverse oppervlakten.

Multispray is een multifunctioneel kleurloos smeer- en onderhoudsmiddel. Reinigt en beschermt, maakt vastgeroeste delen los. Heeft een actief waterverdringend vermogen

TYPE	ARTNR.	EURO	VERP.	VERP.
Siliconenspray	AK130	9,10	300 ml	12
Multispray (WD40)	AK138	8,40	300 ml	12



## GLIJMIDDEL GRIFFON P-20

code 151

Thixotroop smeermiddel voor de montage van schuifmof verbindingen met rubbering afdichtingen. Toepasbaar in buissystemen van PVC, Polypropyleen, ABS, ASA etc... in druk- en afvoersystemen. GRIFFON P-20 bevat geen, voor de gezondheid, schadelijke stoffen. Voldoet aan: KIWA VGB 27 a.

**kiwa**

TYPE	ART.NR	EURO	VERP.	VERP.
Pot 800gr KIWA	AK135	12,00	800 gr	12



## GLIJMIDDEL SPUITBUS

code 151

Zuurvrij glijmiddel voor het efficiënt verbinden van leidingsystemen met manchetverbinding. Op basis van siliconen.

TYPE	ART.NR	EURO	VERP.	VERP.
Glijmiddel spuitbus	AK136	8,50	400 ml	12

